



PREMIER
COPPER PRODUCTS

MODEL NUMBER: VREC19SKDB

- * Description: 19" Rectangle Skirted Vessel Hammered Copper Sink
- * Outer Dimension: 19" x 16" x 5"
- * Inner Dimension: 17" x 14"
- * Skirt: 2.5"
- * Drain Opening: 1.5"
- * Finish: Oil Rubbed Bronze

CODE/STANDARD COMPLIANCE

* IAPMO/cUPC LISTED



* ORB: Oil Rubbed Bronze

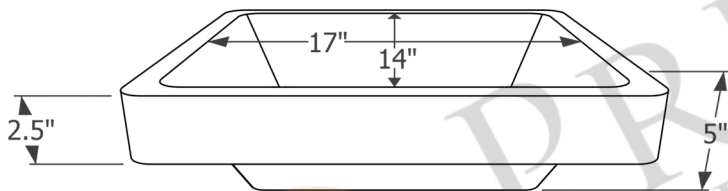
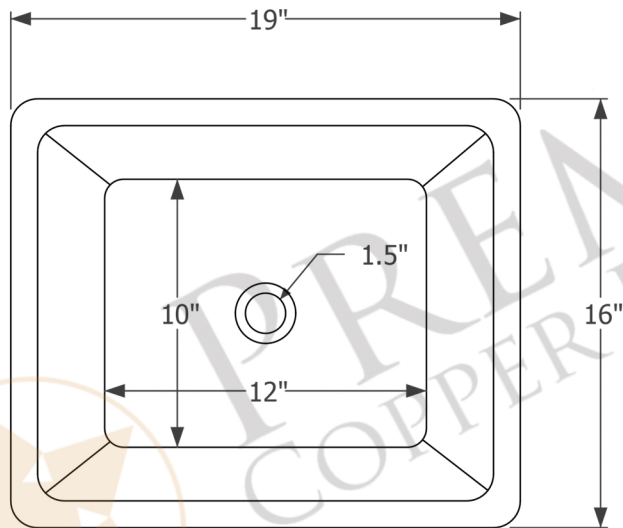

THIS PRODUCT IS HAND CRAFTED, SMALL VARIANCES IN COLOR AND SIZE MAY OCCUR.
DO NOT MAKE ANY INSTALLATION CUTS UNTIL YOU RECEIVE YOUR ITEM(S).